

POE Security Camera System

Quick Start Guide



Table of Contents

Chapter1 System Requirement.....	- 1 -
Chapter 2 Network Connection.....	- 2 -
2.1 Setting the Network Camera over the LAN	- 2 -
2.2 Wiring over the LAN	- 2 -
Chapter 3 Access to the Network Camera	- 4 -
3.1 Accessing by Web Browsers	- 4 -
3.2 Web login.....	- 6 -
Chapter 4 Camera Connection to NVR.....	- 11 -
Chapter5 Frequently Asked Questions.....	- 12 -
5.1 Why can't I open the default IP address 192.168.1.110 via web browser ?-	12 -
5.2 How to reset the password ?	- 12-
5.3 How to upgrade the IP camera ?	- 13 -
5.4 How to fetch the RTSP video stream and http snapshot ?	- 13 -
5.5 Why does the NVR not show image after adding your IP camera ?.....	- 13 -
5.6 How to make the NVR record in motion detection mode ?	- 13 -

Chapter 1 System Requirement

Operating System

Microsoft Windows XP SP1/7/8/10

CPU

3.0 GHz or higher

RAM

4G or higher

Display

1024×768 resolution or higher

Web Browser

For camera that supports plug-in free live view

Internet Explorer 8 – 11, Mozilla Firefox 30.0 and above version and Google Chrome 41.0 and above version.

Note:

For Google Chrome 45 and its above version or Mozilla Firefox 52 and its above version which are plug-in free, **Picture** and **Playback** functions are hidden.

To use mentioned functions via web browser, change to their lower version, or change to Internet Explorer 8.0 and above version.

Chapter 2 Network Connection

2.1 Setting the Network Camera over the LAN

Purpose:

To view and configure the camera via a LAN, you need to connect the network camera in the same subnet with your computer, and install the **AjDevTools** or **SADP** software to search and change the IP of the network camera.

Tools: <http://ourdownload.store/>

AjDevTools: [Download](#)

SADP: [Download](#)

2.2 Wiring over the LAN

The following figures show the two ways of cable connection of a network camera and a computer:

Purpose:

- ① To test the network camera, you can directly connect the network camera to the computer with a network cable. (Connecting directly must supply the camera with DC 12V power supply)

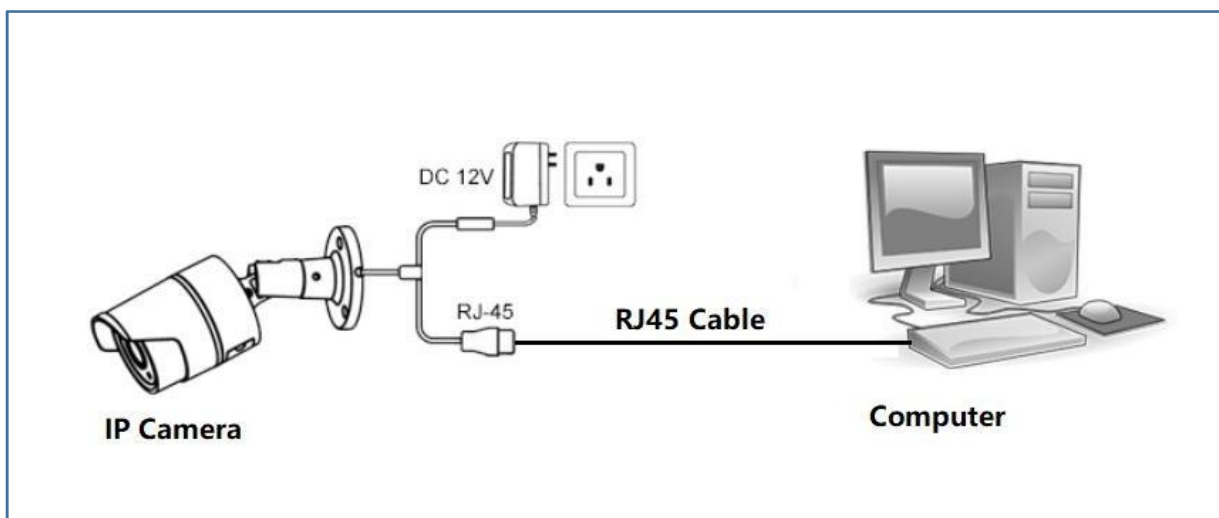

Connecting Directly

- ② Set network camera over the LAN via a switch or a router. (If it is a POE switch, you do not need to power the camera).

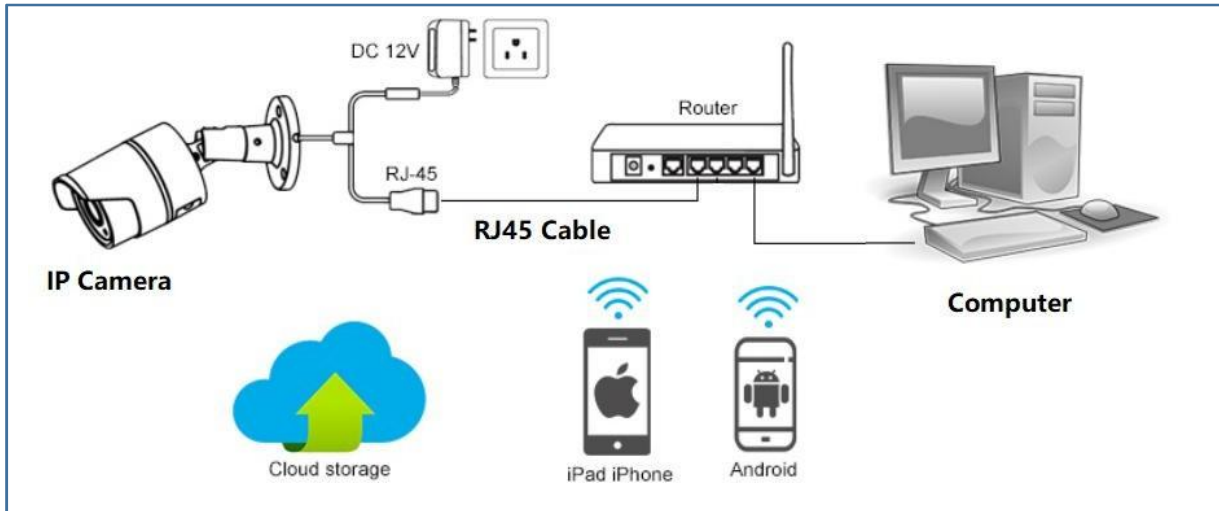

Connecting via a Router or a Switch

- ③ Connect cameras to NVR.

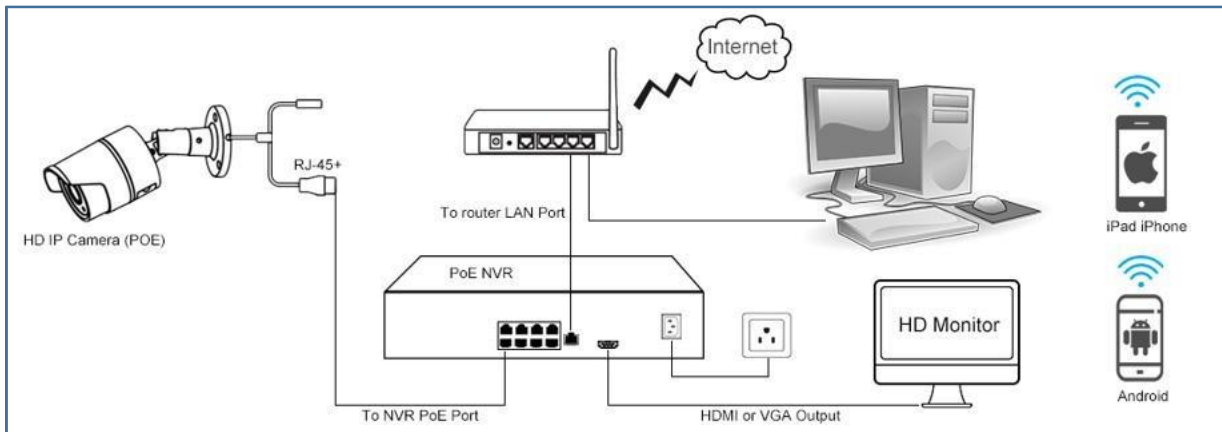

NVR with POE

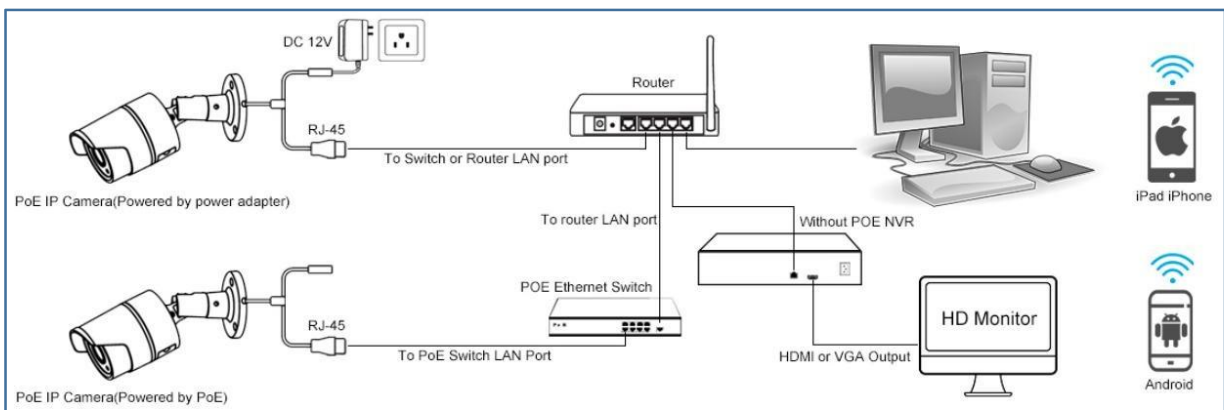

NVR without POE

Chapter 3 Access to the Network Camera

3.1 Accessing by Web Browsers

Steps:

- 1.Computer download and install the AjDevTools or SADP software tool.
- 2.After installation,open the software and click the Start Search.

- ① Search for the IP address of the camera;
- ② Query the IP address of the Camera;

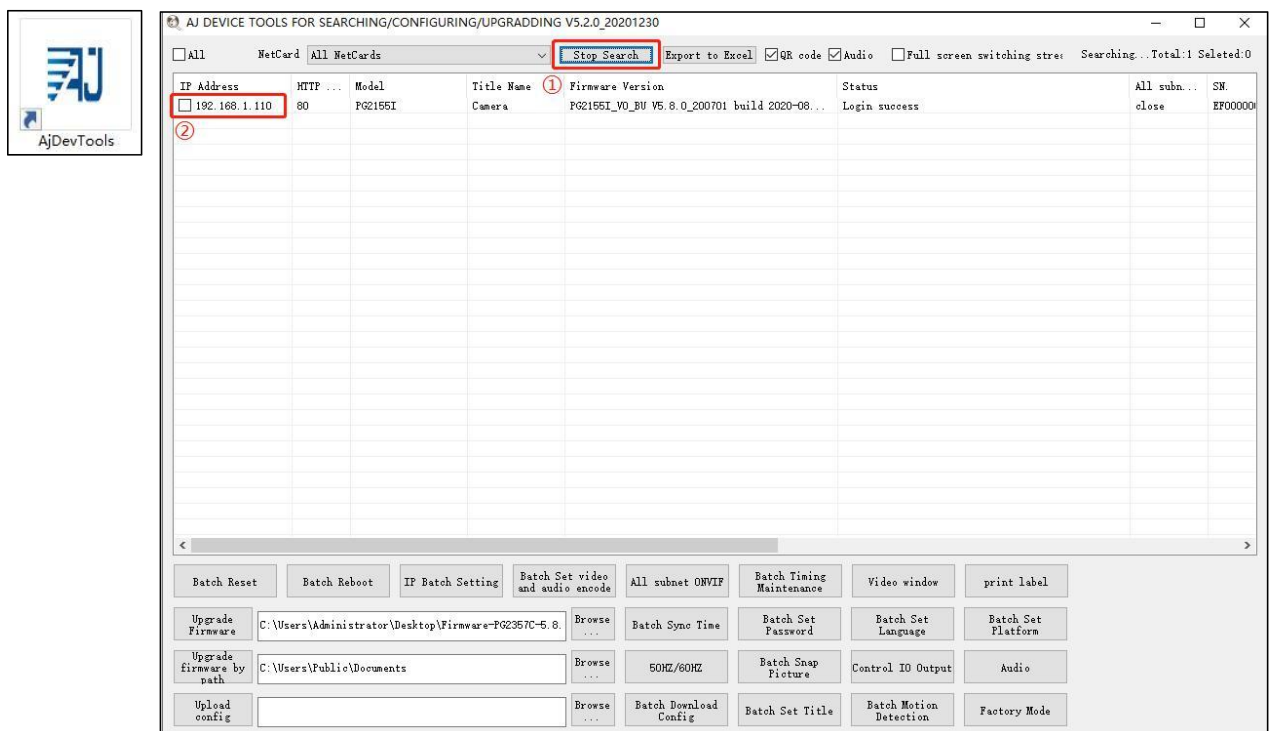

- 3.Modify the IP address of the camera and computer in the same network segment

Setting method: ① Select the IP address of the camera;

- ② Click IP Batch Manual Setting IP address;

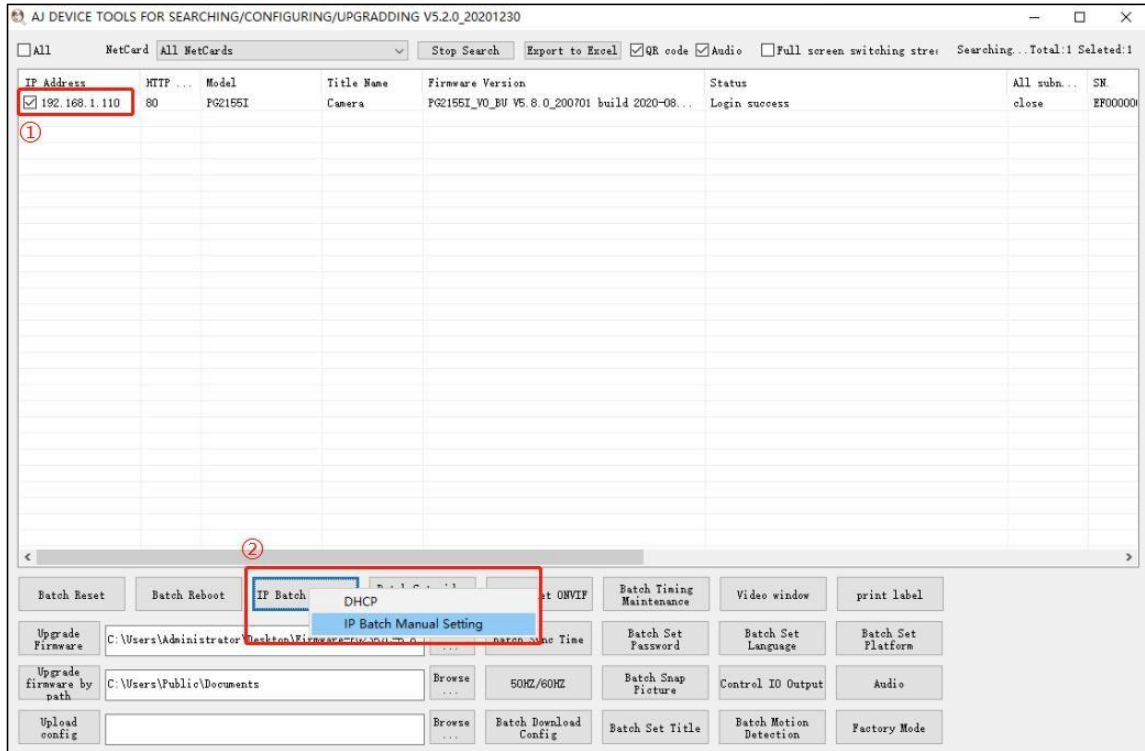

③ Modify the IP address of the camera to be in the same network segment as the IP address of the computer or choose DHCP to obtain an IP address automatically;

④ Select OK--Successfully modified;

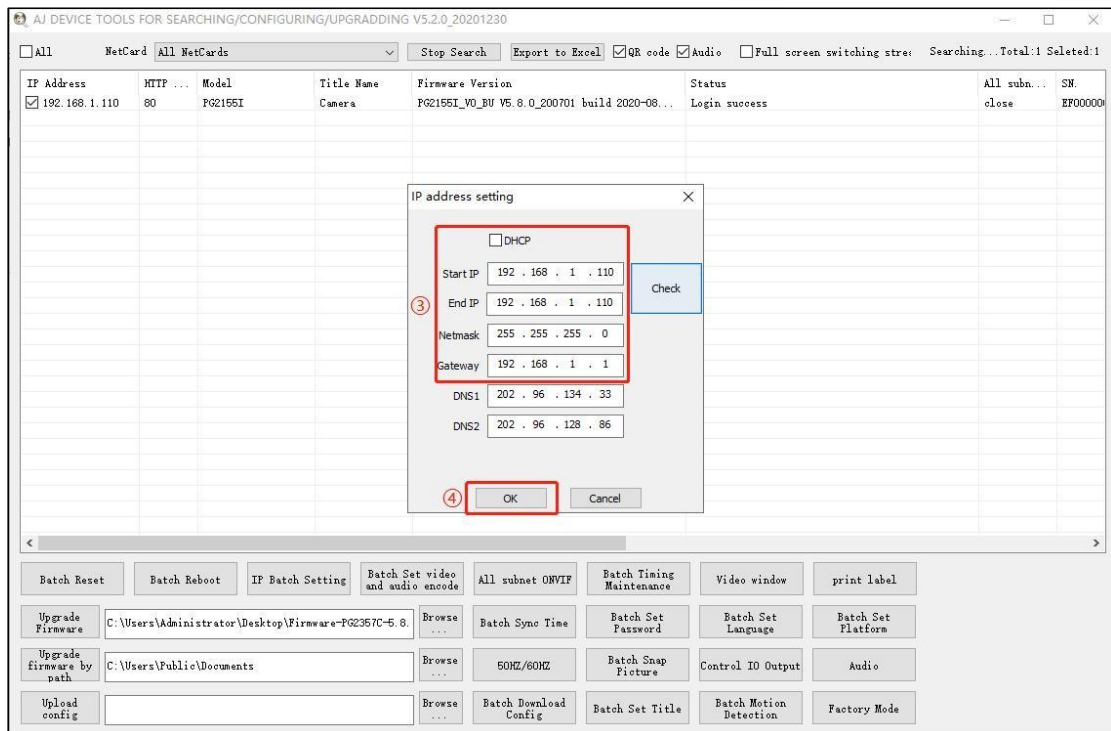

5. The status shows that the Login success, it can be accessed by the computer Web; If you want to configure the camera, click on "Remote configuration" or "Open Web Page".

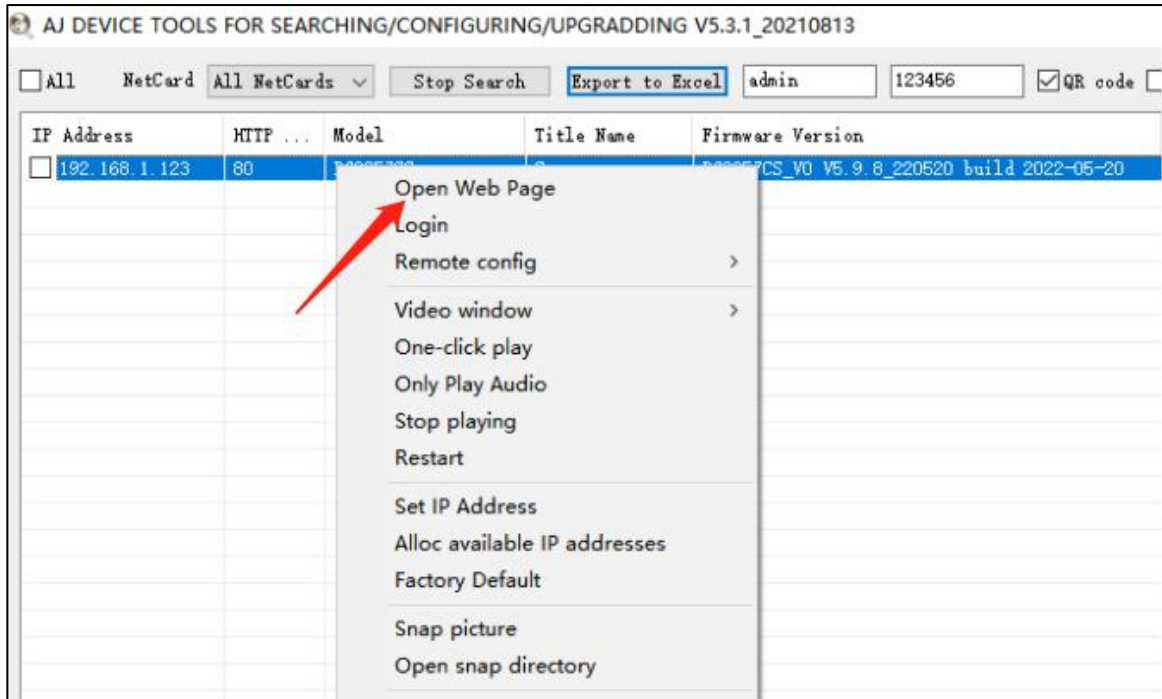

3.2 Web login

1. Open the web browser or click Go to web;
2. In the browser address bar, input the IP address of the network camera, and press the Enter key to enter the login interface;
3. Input the user name and password and click Login.

Note:

The default IP address is **192.168.1.110**. Username: **admin** Password: **123456**
First login Click **“install Web Plug-in”** when prompted.

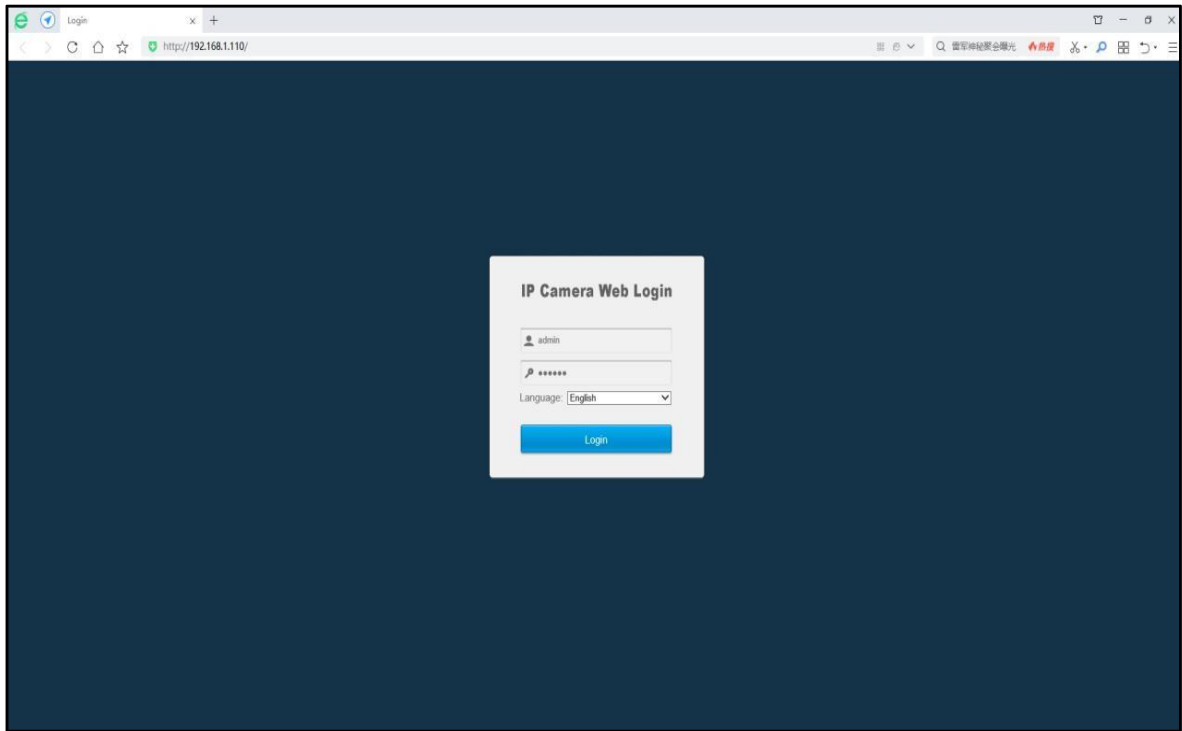

- ① You have to download and run the exable as administrato
- ② If failed to install plug-in, download and save the WEBConfig.exe tocomputer, close all browsers then re-install it.

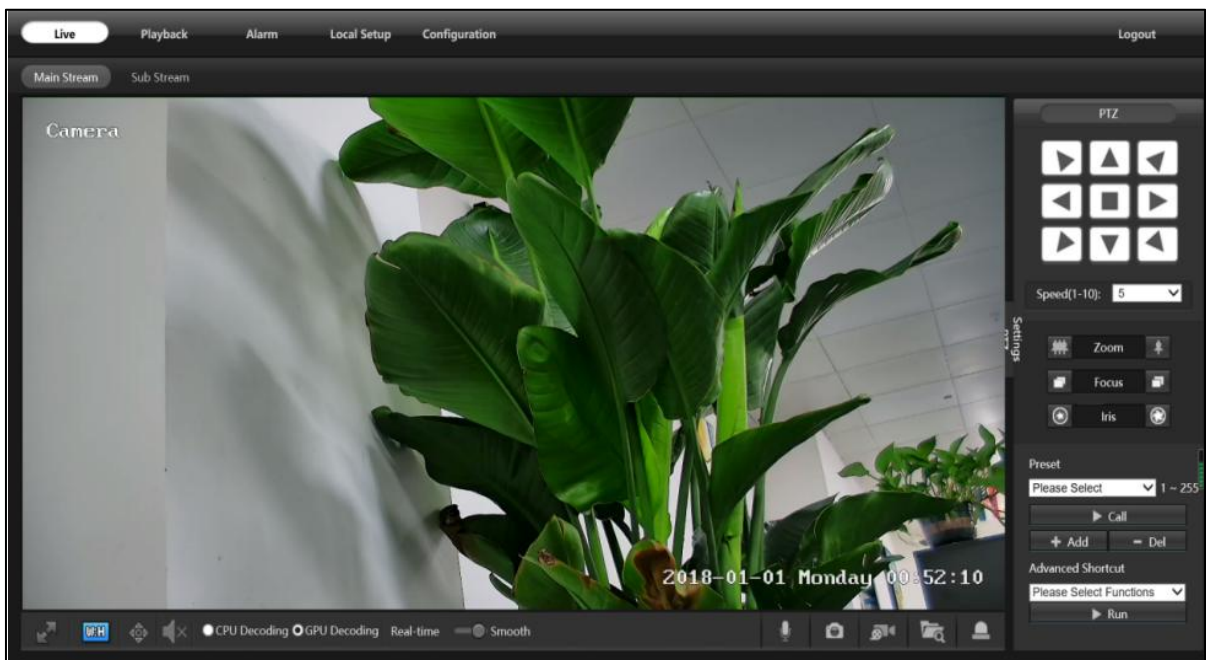

- ③ If there is a delay in video response when accessing remotely, please switch to Sub Stream instead. To learn the function of each button, just put themouse on, it will show screen tips.
- ④ P2P function settings

Steps:Configuration > Camera > Image >Image.



Using the P2P ID and QR code, you can access the camera remotely anywhere via smart phone with Internet access.

Please register an account via mobile phone after installing the AC18Pro APP from APP Store or Google Play Market, then log in and add your camera to start previewing.

P2P function add steps:

Visit the Apple App Store or the Google Play Store to download the AC18Pro app for iOS or Android devices.

Scan QR code download

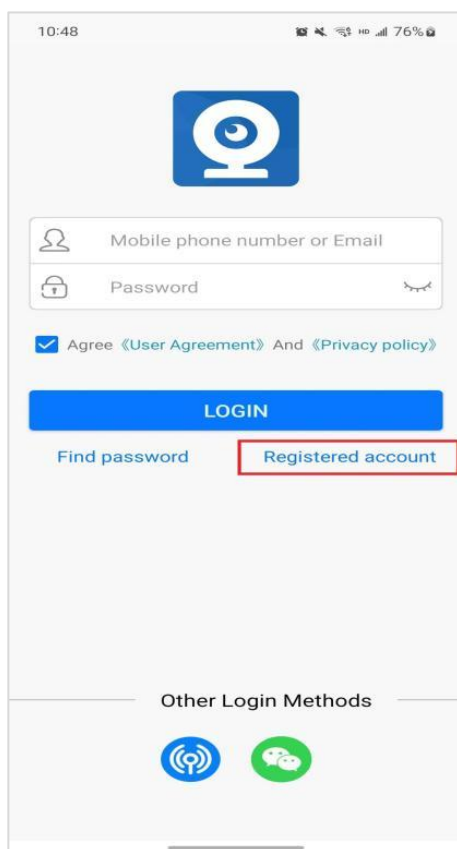

①

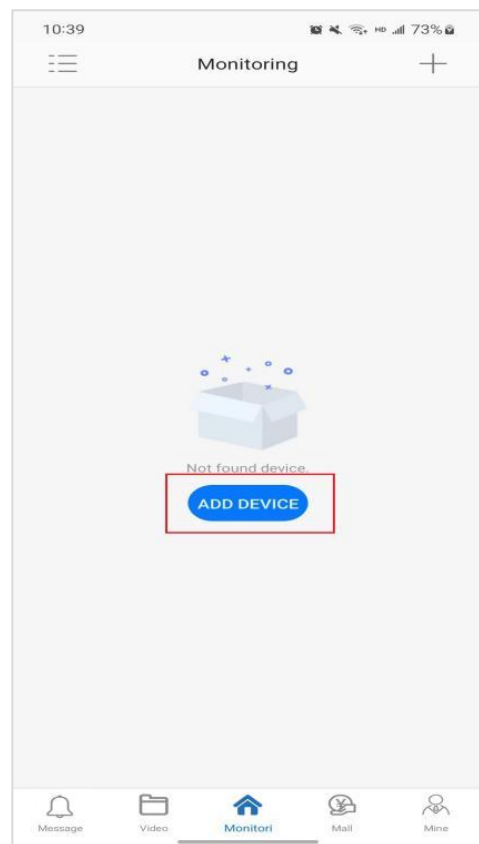

②

- ① For new users, please select “registered account”.In the following page, Create Account ,and enter your email or mobile number.Fill in the received verification code.
- ② Login with a registered account,Select to Add devices,Select “Wired connection” to get into the scan camera QR code page.

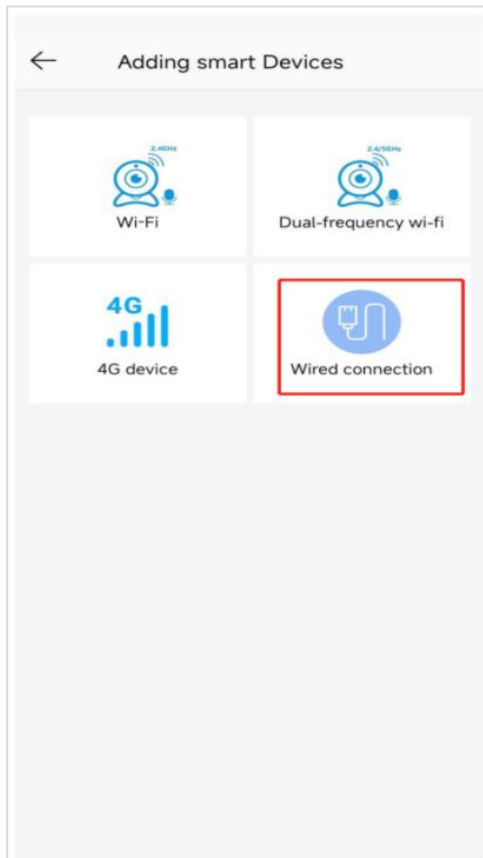

③

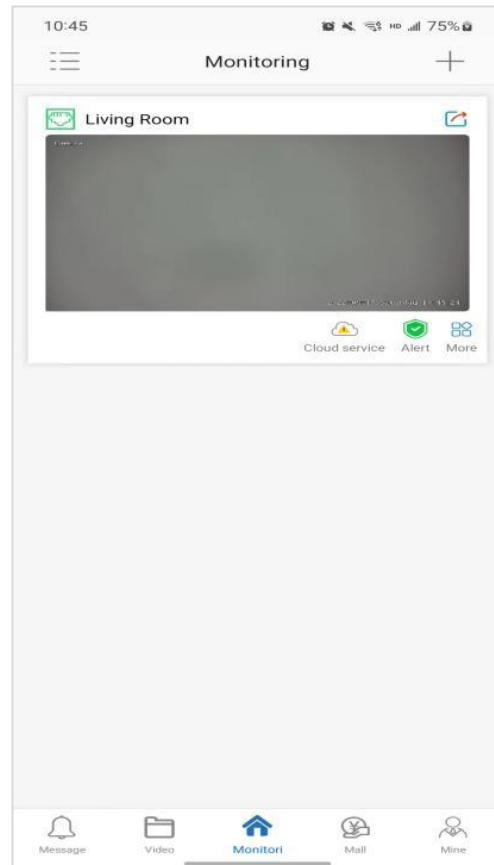

④

- ③ Scan the QR code of the P2P interface displayed on the web side of the camera-> Choose Name you Device.The camera has been successfully added to the phone.
- ④ select the camera list to start viewing video.

Tips:



- ① Select **More** to check your account profile and configure settings on .
- ② To share your camera with your friends or another user, click  icon and type in or scan his/her AC18Pro account.

Note:

If you can not connect the camera, please check your Internet connection and verify the IP address, gateway, and DNS setting in the camera. The Cloud login status should be online, which means the camera has registered to the cloud server.

Chapter 4 Camera Connection to NVR

There are two ways that connect to NVR (two types of NVR)

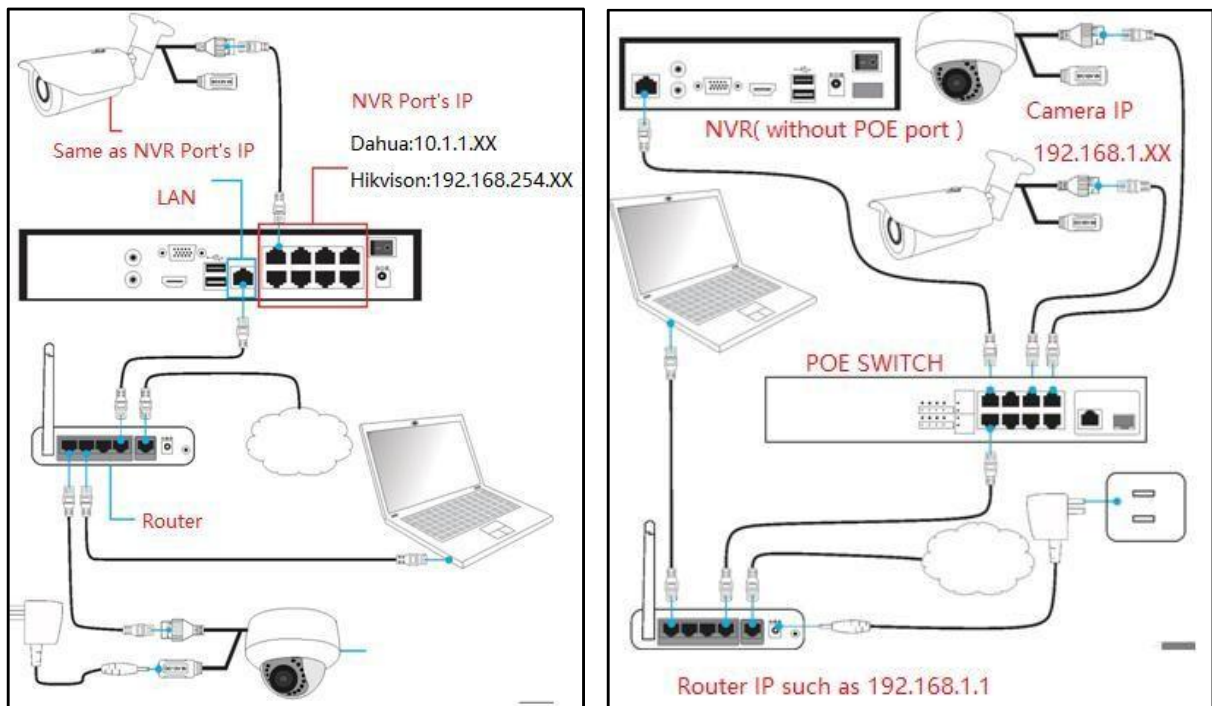

① Connect to POE port NVR

② Connect to Without POE port NVR

The camera can work with Hikvision POE NVR, Plug and Play, besides, the IP camera also supports standard ONVIF protocol, which can be added to third-party video recorder easily with ONVIF.

Note:

- ① Before connecting cameras to NVR that has POE switch ,make sure the NVR and cameras have valid IP scheme that matches each other.(e.g.: Dahua NVR POE Port's IP Network Segment is 10.1.1.XX, so the camera IP must be 10.1.1.XX)
- ② Before connecting cameras to NVR that has no POE switch, make sure the NVR , cameras and the POE switch router have valid IP scheme that matches each other.(e.g.: POE switch router router's IP is 192.168.1.1, so the camera IP must be 192.168.1.XX)
- ③ Some POE NVR models support plug and play (such as Hikvision POE NVR), if the "Plug & Play" feature is not available or not applicable, please add camera manually

Chapter 5 Frequently Asked Questions

5.1 Why can't I open the default IP address 192.168.1.110 via web browser ?

The default IP address may not match your LAN's IP scheme. Check your computer's IP address before accessing the camera. If the IP address does not match the 192.168.1.x scheme, please install the IP search tool from the download website to modify the camera's IP address. Make sure the IP address of the camera matches the LAN IP scheme. For example, if your LAN is 192.168.0.xxx, then set the IP camera to 192.168.0.123 and so on.

5.2 How to reset the password ?

The default Username: admin, Password: 123456. If you lost the password or want to reset the camera's setting, please install the search tool to search the camera IP and click **Batch Reset** button.

5.3 How to upgrade the IP camera ?

- ① Ask the supplier for the suitable firmware.
- ② You can use the web browser, search tool, or PC client to upgrade the camera.
- ③ Go to the **Configuration > System > update**, click **browse** and select the firmware, then click **Upgrade** button and wait for the operation to complete.

5.4 How to fetch the RTSP video stream and http snapshot ?

- ① Main Stream: rtsp://admin:123456@IP address/stream0
- ② Sub Stream: rtsp://admin:123456@IP address/stream1

5.5 Why does the NVR not show image after adding your IP camera ?

- ① Make sure you selected the right protocol and enter the correct username and password when adding the cameras.
- ② Make sure the NVR and IP camera are the same IP scheme.
(eg. NVR:192.168.1.x, and IP camera:192.168.1.y).
- ③ Try changing the camera encode mode to H.264 if the NVR can't support H.265. (**Configuration -> Camera -> Video > Encode mode: H.264**)

5.6 How to make the NVR record in motion detection mode ?

- ① Enable the IP camera motion detection function via web browser.
- ② Add the IP camera via ONVIF protocol.
- ③ Change the NVR record mode to Motion Detection mode.
- ④ Check the NVR screen motion detection icon and try playback (Please refer to your NVR's manual for NVR's motion record option.)

